

Article number: 20241028370

Description: E+G Telescope-Lear motion bearings GN 2410-28-370

Measures

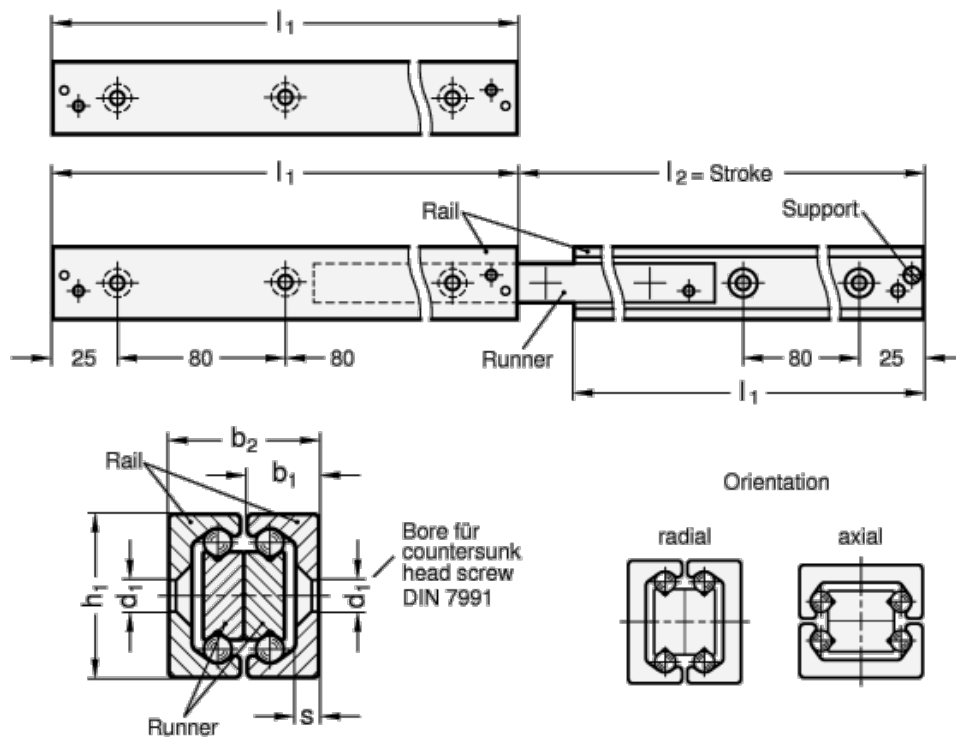

b1	= 12.3
b2	= 25.8
d1	= M5
d2	= 5.5
h1	= 28
L1	= 370 - 380
s	= 4
Weight in (g)	= 1630